

FILTER - INLINE SPIN ON - IFR 2

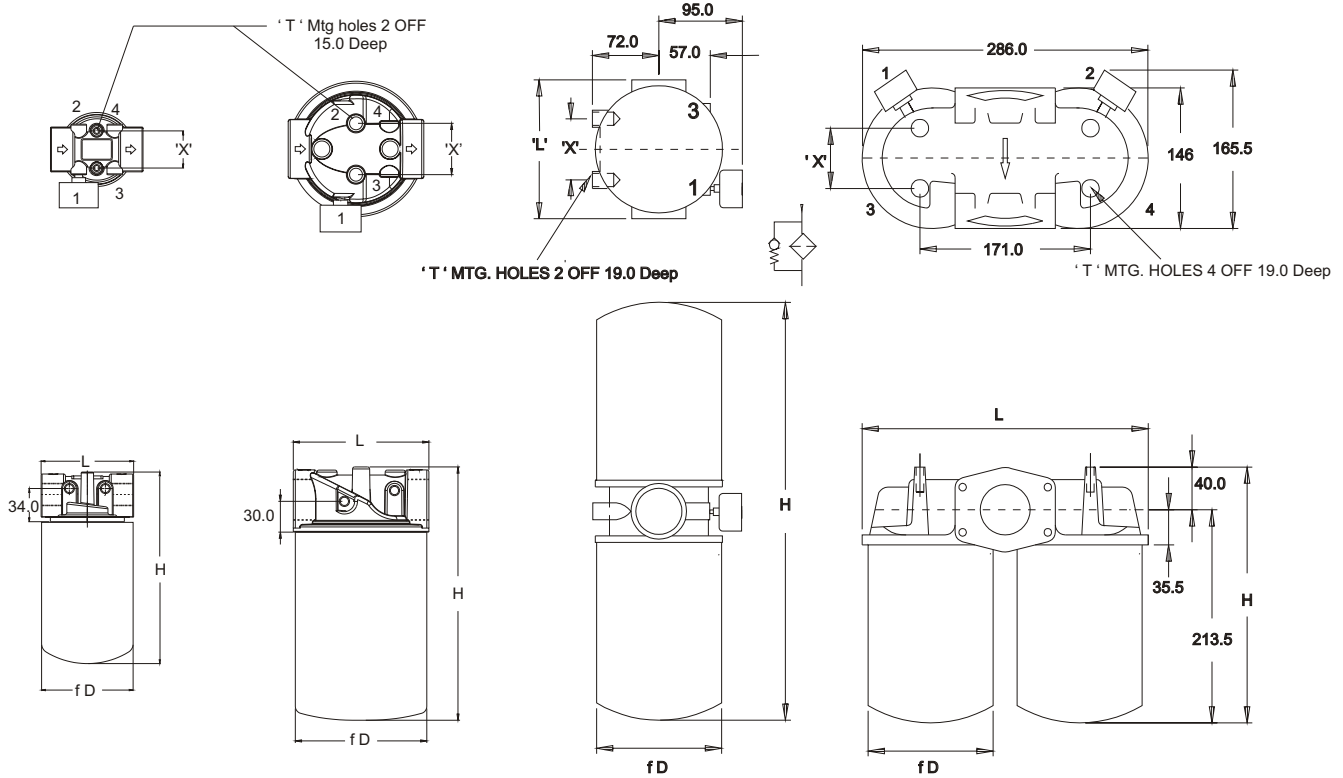

- DISPOSABLE SPIN ON
- DIE CAST ALUMINIUM HEAD
- 9 SIZES FLOWS TO 400 LPM
- MAX. PRESSURE 10 BAR / TEST 15 BAR / BURST 20 BAR
- BY PASS STANDARD 1 BAR (SUCTION 0.2 BAR)
- MAX. TEMP. 80 ° C.
- FOR USE WITH MINERAL / PETROLEUM BASED OILS



IF*2.06

IF*2.10

IF*2.12 V

IF*2.12 H

MODEL CODE	L	D	H	X	MOUNTING HOLES		GAUGE PORT		WT KGS
					NOS	T SIZE	NOS	NPT	
IF * 2 . 06 . 10	95	93	150	38	2 OFF	M 6 X 1.0 (Std) 1/4"-20UNC	2 OFF	1 / 8"	0.80
IF * 2 . 06 . 20	95	93	196	38	2 OFF		2 OFF	1 / 8"	1.00
IF * 2 . 06 . 30	95	93	263	50	2 OFF		2 OFF	1 / 8"	1.20
IF * 2 . 10 . 50	132	129	249	50	2 OFF	M 8 X 1.25 (Std) 5/16"-18UNC	2 OFF	1 / 8"	2.20
IF * 2 . 10 . 65	132	129	294	50	2 OFF		2 OFF	1 / 8"	2.40
IF * 2 . 12 V . 80	148	129	431	65	2 OFF	M 10 X 1.5 (Std)	2 OFF	1 / 8"	3.60
IF * 2 . 12 V . 100	148	129	522	65	2 OFF		2 OFF	1 / 8"	4.00
IF * 2 . 12 H . 80	286	129	273	60	4 OFF	3/8" - 18UNC	2 OFF	1 / 8"	5.50
IF * 2 . 12 H . 100	286	129	317	60	4 OFF		2 OFF	1 / 8"	6.20

DIMENSIONS IN MM FOR REFERENCE ONLY

FILTER - INLINE SPIN ON - IFR 2



HEAD CASTING

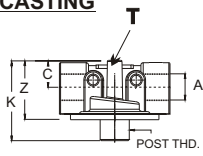

IF*2.06
IF*2.08

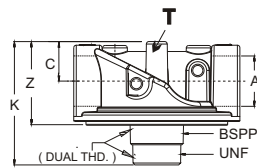

IF*2.10

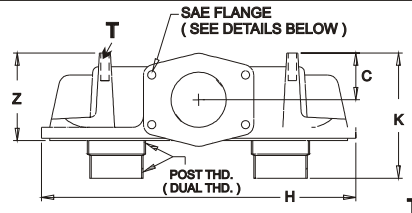

IF*2- 12 H

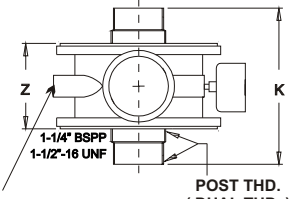

IF*2-12 V



MODEL	PORT THD. 'A'	POST THD	C	K	Z	H	WT KGS
IF* 2 . 06	3 / 4"	BSPP	22	67	51	-	0.4
IF* 2 . 08	1"	BSPP					
IF* 2 . 10	1-1 / 4"	BSPP DUAL THD	29	100	64	-	1.0
IF* 2 . 12 V	1-1 / 2"	BSPP DUAL THD	-	140	70	-	1.2
IF* 2 . 12 H *	(Refer Table Below)	DUAL THD	50	122	91	286	3.0

IFR 2 - 12 H *	Connection	Port	HP Ref
B	1-1/2" BSP	Thread	12B
N	1-1/2" NPT	Thread	12N
C	1-7/8"-12UNF	Thread	24S
D*	2"SAE Flange	Flange	16SF
E	1-1/4" BSP	Thread	10B
F	1-1/4" NPT	Thread	10N
H	1-5/8"-12UNF	Thread	20S
J*	1-1/2"SAE Flange	Flange	12SF
K*	1-1/2"SAE Flange & 1-1/4"NPT	Flange & Thread	12SF 10N
L*	1-1/2"SAE Flange & 1-5/8"-12U	Flange & Thread	12SF 20S
M*	2"SAE Flange & 1-1/2"NPT	Flange & Thread	16SF 12N
P*	2"SAE Flange & 1-7/8"-12U	Flange & Thread	16SF 24S

* ADD 1 FOR SAE FLANGE WITH M12 x 1.75 BOLT. OMIT IF UNC STD.

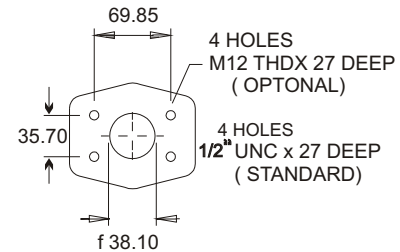

1-1/2" SAE FLANGE

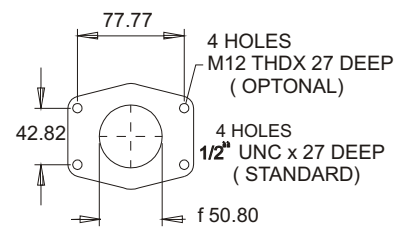

2" SAE FLANGE

SAE FLANGE DETAILS

CARTRIDGE	D	L	FILTRATION AREA CM ²			WT
			P10/ P25	A10/ A25	M125	KGS
S/E - 10 - ** - *	93	100	1500	1200	650	0.4
S/E - 20 - ** - *	93	146	2300	1840	900	0.6
S/E - 30 - ** - *	93	212	4200	3300	1250	0.8
IFE - 50 - ** - *	129	180	5600	3900	2000	1.2
IFE - 65 - ** - *	129	227	7850	4800	2400	1.4

ELEMENT

B - 3/4" BSP

U - 1" UNF X 12 T.P.I.

1 - 1/4" BSPP

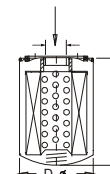

S/E - 20 - ** - *

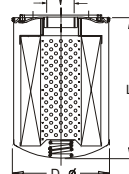

IFE - 50 - ** - B

DIMENSIONS IN MM FOR REFERENCE ONLY

FILTER - INLINE SPIN ON - IFR 2



MODEL CODE : ASSEMBLY

IF	R 2	- 06*	- 50	- 10	B	- *	- *	
SERIES		PORT CONNECTION		SIZE ELEMENT	FILTRATION μ MICRONS	POST THREAD	BYPASS SPECIAL #	MTG. HOLES -*
B - NO BYPASS		06 B - 3/4" BSPP	10 - 35 LPM	P10 - 10 μ NOM	B - 3/4" BSPP	R3 - 15 PSI Std	M - M6 x 1.0(std)	
		06 N - 3/4" NPT						
		12 S - 1-1/16" UNF - 12						
R - RETURN		08 B - 1" BSPP	20 - 70 LPM	P25 - 25 μ NOM	U - 1" -12 UNF	R4 - 25 PSI	U - 1/4"-20 UNC	
		08 N - 1" NPT						
		16 S - 1-5/16" UNF - 12						
S - SUCTION		10 B - 1-1/4" BSPP	50 - 150 LPM	A10 - 10 μ ABS	B - 1- 1/4 BSPP	S1 - 3 PSI Std	M - M8x1.25(std)	
		10 N - 1-1/4" NPT						
		20 S - 1- 5/8" UNF - 12						
		12 V B - 1-1/2" BSPP	80 - 300 LPM	M125 - 125 μ MESH		S2 - 5 PSI	M - M10x1.5(std)	
		12 V N - 1-1/2" NPT						
		12 V S - 1- 7/8" UNF - 12						
		12 H * - REFER TABLE	100 - 400 LPM			OMIT IF STD	U - 3/8"-20UNC	
						OMIT IF STD	OMIT IF STD	

INDICATOR : OPTIONAL (TO BE ORDERED SEPERATELY)

GR - VISUAL RETURN ER - ELEC. RETURN
GS - VISUAL SUCTION ES - ELEC. SUCTION

Element : P10 / P25 Was 010 / 025

Indicator ports: R - 2 off x 1/8" NPT inlet
Standard S - 2 off x 1/8" NPT outlet
B - 4 off x 1/8" NPT inlet & outlet

Position

[1 - 2]
[3 - 4]
[1 - 2 - 3 - 4]

MODEL CODE : HEAD CASTING

IF	R 2	- 06*	B	- *	- *	
SERIES		PORT CONNECTION		POST THREAD	BYPASS SPECIAL #	MTG. HOLES -*
B - NO BYPASS		06 B - 3/4" BSPP	B - 3/4" BSPP	R3 - 15 PSI Std	M - M6 x 1.0(std)	
		06 N - 3/4" NPT				
		12 S - 1-1/16" UNF - 12				
R - RETURN		08 B - 1" BSPP	U - 1" -12 UNF	R4 - 25 PSI	U - 1/4"-20 UNC	
		08 N - 1" NPT				
		16 S - 1-5/16" UNF - 12				
S - SUCTION		10 B - 1-1/4" BSPP	1-1/4" BSPP & Dual Thread Std	S1 - 3 PSI Std	M - M8x1.25(std)	
		10 N - 1-1/4" NPT				
		20 S - 1- 5/8" UNF - 12				
		12 V B - 1-1/2" BSPP	1-1/2"-16 UN Dual Thread Std	S2 - 5 PSI	M - M10x1.5(std)	
		12 V N - 1-1/2" NPT				
		12 V S - 1- 7/8" UNF - 12				
		12 H * - REFER TABLE		OMIT IF STD	U - 3/8"-20UNC	
					OMIT IF STD	

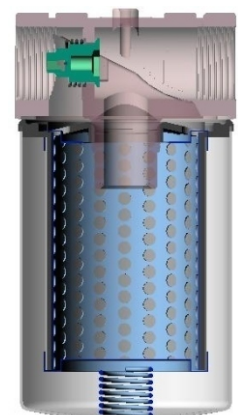

MODEL CODE : ELEMENT

***	- 50	- 10	B
SERIES	ELEMENT SIZE	FILTRATION μ MICRONS	POST THREAD
S/E	10 - 35 LPM	P10 - 10 μ NOM	B - 3/4" BSPP U - 1" -12 UNF
	20 - 70 LPM	P25 - 25 μ NOM	
	30 - 100LPM	A10 - 10 μ ABS	
IFE	50 - 150LPM	A25 - 25 μ ABS	B - 1- 1/4 " BSPP
	65 - 200LPM	M125 - 125 μ MESH	

OPTIONAL / SPECIAL FEATURE - OMIT IF NOT REQUIRED
CONSULT FACTORY FOR OPTIONAL / SPECIAL FEATURE